

Convert from O_E, O_Z and Output current

ZOY—Series
Intelligent Zirconia Oxygen Analyzer

Technical Manual

(All Rights Reserved)

E (mV)	O _Z (%)	4-20mA				0-10mA			
		0-25	0-20	0-10	0-5	0-25	0-20	0-10	0-5
117.41	0.1	4.064	4.08	4.16	4.32	0.04	0.05	0.10	0.20
93.20	0.3	4.192	4.24	4.48	4.96	0.12	0.15	0.30	0.60
81.94	0.5	4.32	4.40	4.80	5.60	0.20	0.25	0.50	1.00
71.59	0.8	4.512	4.64	5.28	6.56	0.32	0.40	0.80	1.60
66.67	1.0	4.64	4.80	5.60	7.20	0.40	0.50	1.00	2.00
51.39	2.0	5.28	5.60	7.20	10.40	0.80	1.00	2.00	4.00
42.46	3.0	5.92	6.40	8.80	13.60	1.20	1.50	3.00	6.00
36.11	4.0	6.56	7.20	10.40	16.80	1.60	2.00	4.00	8.00
31.20	5.0	7.20	8.00	12.00	20.00	2.00	2.50	5.00	10.00
27.18	6.0	7.84	8.80	13.60		2.40	3.00	6.00	
23.78	7.0	8.48	9.60	15.20		2.80	3.50	7.00	
20.84	8.0	9.12	10.4	16.80		3.20	4.00	8.00	
18.25	9.0	9.76	11.2	18.40		3.60	4.50	9.00	
15.92	10.0	10.40	12.0	20.00		4.00	5.00	10.00	
11.91	12.0	11.68	13.6			4.80	6.00		
8.51	14.0	12.96	15.2			5.60	7.00		
5.57	16.0	14.24	16.8			6.40	8.00		
2.97	18.0	15.52	18.4			7.20	9.00		
0.65	20.0	16.80	20.0			8.00	10.00		
0.54	20.1	16.864				8.04			
0.00	20.6	17.184				8.24			
-4.27	25.0	20.00				10.00			

CN Boiler Engineering Solution LLC

一 Application

ZOY-series intelligent zirconia oxygen analyzer is a practical and reliable automatic analyzer. It can coordinating role with each kind of electric unit instrument, the conventional demonstration recording instrument and the DCS distributed control system. May to fuel-burning equipment and so on boiler, kiln stove, heating furnace the haze content which produces in the combustion process carry on fast, the correct online examination analysis. Realizes the low oxygen combustion control, serves the energy conservation purpose, reduces the environmental pollution.

ZOY-series intelligent zirconia oxygen analyzer includes two parts: ZOY-zirconia probe (primary instrument) and ZOY-oxygen transmitter (secondary instrument).

二 Working Princip

1. Zirconia zirconium tube is a metal oxide, the solid state electrolyte which forms under the high temperature has the conduction oxygen ion characteristic.

The measured gas (flue gas) enters the medial of zirconia zirconium tube through the probe filter. The reference gas (air) enters the lateral of probe zirconia zirconium tube through the natural convection. When in the zirconium tube the flank oxygen concentration is different, the both sides will have the oxygen thick bad electromotive force inside and outside the zirconium oxide zirconium tube. (see fig 1)

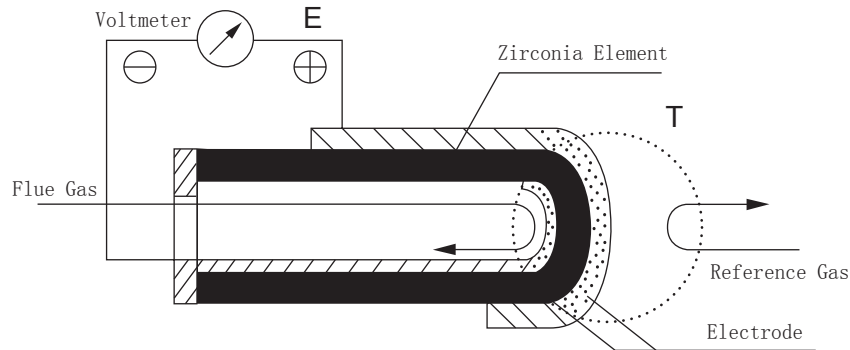

Fig 1 Concentration Cell

Connected to the Attached List 1

E (mV) / T (°C)	Oz%														
	12	13	14	15	16	17	18	19	20	21	22	23	24	25	
600	10.16	8.66	7.26	5.97	4.75	3.61	2.54	1.52	0	-0.360	-1.24	-2.07	-2.87	-3.64	
610	10.28	8.76	7.36	6.03	4.81	3.65	2.57	1.54	0	-0.366	-1.25	-2.10	-2.91	-3.68	
620	10.39	8.85	7.42	6.10	4.86	3.69	2.60	1.56	0	-0.370	-1.26	-2.12	-2.94	-3.72	
630	10.51	8.95	7.51	6.17	4.91	3.74	2.62	1.57	0	-0.374	-1.28	-2.14	-2.97	-3.77	
640	10.63	8.05	7.60	6.24	4.97	3.78	2.65	1.59	0	-0.378	-1.29	-2.17	-3.00	-3.81	
650	10.74	9.15	7.68	6.31	5.02	3.82	2.68	1.61	0	-0.382	-1.31	-2.19	-3.04	-3.85	
660	10.86	9.25	7.76	6.38	5.08	3.86	2.61	1.62	0	-0.386	-1.32	-2.21	-3.07	-3.89	
670	11.98	9.35	7.85	6.44	5.13	3.90	2.74	1.64	0	-0.391	-1.34	-2.24	-3.10	-3.93	
680	11.09	9.45	7.93	6.51	5.19	3.94	2.77	1.66	0	-0.395	-1.35	-2.26	-3.14	-3.97	
690	11.21	9.55	8.01	6.58	5.24	3.98	2.80	1.68	0	-0.399	-1.36	-2.29	-3.17	-4.02	
700	11.33	9.65	8.09	6.65	5.30	4.03	2.83	1.69	0	-0.403	-1.38	-2.31	-3.20	-4.06	
710	11.44	9.75	8.18	6.72	5.35	4.07	2.86	1.71	0	-0.407	-1.39	-2.33	-3.23	-4.10	
720	11.56	9.85	8.26	6.79	5.40	4.11	2.89	1.73	0	-0.411	-1.41	-2.36	-3.27	-4.14	
730	11.67	9.94	8.34	6.85	5.46	4.15	2.91	1.75	0	-0.418	-1.42	-2.38	-3.30	-4.18	
740	11.79	10.04	8.43	6.92	5.51	4.19	2.94	1.76	0	-0.422	-1.43	-2.40	-3.33	-4.22	
750	11.91	10.14	8.51	6.99	5.57	4.23	2.97	1.78	0	-0.426	-1.45	-2.43	-3.37	-4.27	
760	12.02	10.24	8.59	7.05	5.62	4.27	3.00	1.80	0	-0.430	-1.46	-2.45	-3.40	-4.31	
770	12.14	10.34	8.68	7.13	5.68	4.32	3.03	1.82	0	-0.432	-1.48	-2.48	-3.43	-4.35	
780	12.26	10.44	8.76	7.20	5.73	4.36	3.06	1.83	0	-0.436	-1.49	-2.50	-3.47	-4.39	
790	12.37	10.54	8.84	7.26	5.79	4.40	3.09	1.85	0	-0.438	-1.51	-2.52	-3.50	-4.43	
800	12.49	10.64	8.93	7.35	5.84	4.46	3.12	1.87	0	-0.440	-1.52	-2.55	-3.53	-4.47	

Convert from O_Z, O_E and Temperature

E (mV) T (°C)	O _Z %											
	0.5	1	2	3	4	5	6	7	8	9	10	11
600	69.92	58.89	43.85	36.23	30.82	26.62	23.19	20.30	17.79	15.57	13.59	11.80
610	70.72	57.54	44.35	36.64	31.17	26.93	23.46	20.35	17.99	15.75	13.75	11.93
620	71.52	58.19	44.86	37.06	31.52	27.23	23.27	20.76	18.19	15.93	13.90	12.07
630	72.32	58.84	45.36	37.47	31.88	27.54	23.99	20.99	18.40	16.11	14.06	12.20
640	73.12	59.49	45.86	37.89	32.23	27.84	24.26	21.23	18.60	16.28	14.21	12.34
650	73.92	60.14	46.36	38.30	32.58	28.15	24.52	21.46	18.80	16.46	14.37	12.47
660	74.72	60.80	46.87	38.72	32.94	28.45	24.79	21.69	19.01	16.64	14.52	12.61
670	75.53	61.45	47.37	39.13	33.29	28.76	25.05	21.92	19.21	16.82	14.68	12.74
680	76.33	62.10	47.87	39.55	33.64	29.06	25.32	22.16	19.42	17.00	14.83	12.88
690	77.13	62.75	48.37	39.96	34.00	29.37	25.59	22.39	19.62	17.18	14.99	13.01
700	77.93	63.40	42.88	40.38	34.35	29.67	25.85	22.62	19.82	17.53	15.15	13.15
710	78.73	64.05	49.38	40.79	34.70	29.98	26.12	22.85	20.03	17.53	15.30	13.28
720	79.53	64.71	49.88	41.21	35.06	30.28	26.38	23.09	20.03	17.71	15.46	13.42
730	80.33	65.36	50.38	41.62	35.41	30.59	26.65	23.32	20.43	17.89	15.61	13.55
740	81.13	66.01	50.88	42.04	35.76	30.89	26.91	23.55	20.64	18.07	15.77	13.69
750	81.3	66.66	51.39	42.45	36.11	31.20	27.18	23.78	20.84	18.25	15.92	13.82
760	82.73	67.31	51.89	42.87	36.47	31.50	27.45	24.02	21.04	18.42	16.08	13.96
770	83.53	67.96	52.37	43.28	36.82	31.81	27.71	24.25	21.25	18.60	16.24	14.09
780	84.34	68.61	52.89	43.70	37.17	32.11	27.98	24.48	21.45	18.78	16.39	14.23
790	85.14	69.27	53.40	44.11	37.53	32.42	28.24	24.71	21.66	18.96	16.55	14.36
800	85.94	69.94	53.90	44.53	37.88	32.72	28.51	24.95	21.86	19.14	16.70	14.50

The Oxygen Concentration Difference Emf available Nerast formula expression as follows:

$$E_z = \frac{RT}{nF} \ln \frac{P_A}{P_0}$$

- E_Z — Gas Concentration Difference Emf (Unit = mV)
- R — Ideal Gas Constant, 8.314 joule/mole • deg
- T — Absolutely Working Temperature K, 273.16+T°C
- n — Participates in the response the electronic number is 4
- F — Faraday Constant, 96500 coulomb
- P_A — Reference Gas (Air) attempt takes 20.6%
- P₀ — Measured Gas (Flue Gas) Concentration (Unit = %)

Under gas (reference gas) determination, The zirconium probe outputs gas depth difference emf E_Z only in the probe working temperature and was measured that the gas Concentration becomes the function corresponding relationships.

2. ZOY-Oxygen Transmitter leading role is gasifies gas concentration difference emf E_Z which the zirconium probe outputs to transform was measured that the haze air content becomes the linear relationship the electric current signal output.

三、 Contains Model And Technical Specification

3.1 Contains Model

① Zirconium Probe Model Definition

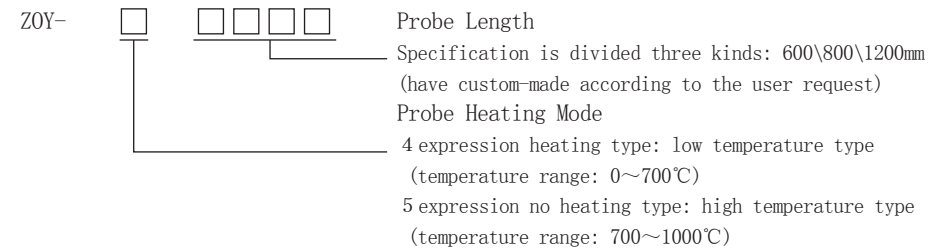

② Oxygen Transmitter Model Definition

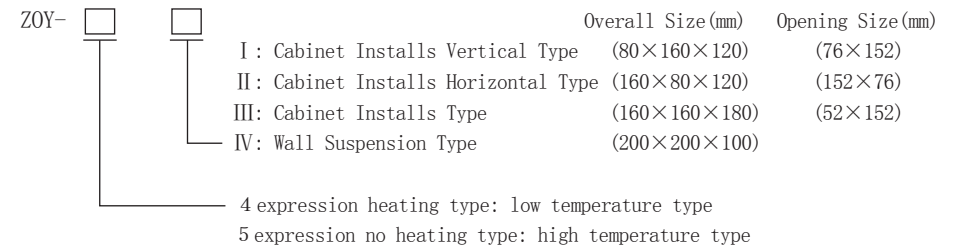

3.2 Technical Specification

1. Basic Error: $< \pm 2\% F \cdot S$, Accuracy of the instrument is 1
2. Range: 0~5%O₂; 0~10%O₂; 0~20%O₂; 0~25%O₂
3. Background Correction: -20mV~+20mV
4. Measured Gas: ZOY-4 Type: below 700°C (low temperature type)
ZOY-5 Type: 700~1000°C (High temperature type)
5. Output Signal: May expand the two-circuit isolation output, 0~10mA DC and 4~20mA DC, adopts the electro-optical isolation. Direct networking with computer.
6. Load Capacity: 0~1.2K Ω or 0~600 Ω
7. Environmental Condition: 0~50°C; Relative Humidity < 90%
8. Power Source: 220V \pm 10%, 50Hz
9. Power Loss: Transmitting instrument: 8W
Heating furnace equally: 50W
10. Response Time: 90% approximately 3s
11. Zirconium Probe Heating Furnace Elevation Of Temperature Time: 20min
12. Zirconium Probe Life: Zirconium Tube according to international GB11169-89 guaranteed usable one year. Main body life above 5 years.

3.3 Specification

1. Zirconium Probe Overall Size(mm) (Fig 2)
L = 400、800、1200mm

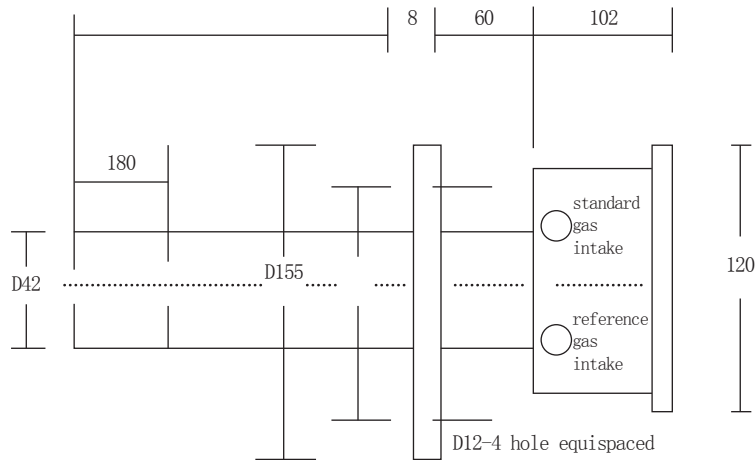

(Fig 2)

the speed of flow is quick, will form the washout to the probe head stainless steel outer covering to corrode, lessens the service life; If after measuring point too, because in the system of heating flues leaks air the phenomenon, will cause the measuring point oxygen size to be high, cannot reflect in the chamber truthfully the flue gas oxygen quantity.

(2) On shaft walls probe head fixed flange:

Makes like Figure six shape transition frame with the steel products, a transition flange can weld directly on the shaft walls outer wall or buries in the shaft walls, but the request aereosal is reliable. The transition another end flange is supposes for the fixed detector, must therefore match with the detector fixed flange's spiral hole. If with $\Phi 12$ mm the installment hole, in the intermediate flange $\Phi 130$ mm in the circle the equispaced four $\Phi 12$ mm installment holes, uses 4 M10 \times 40 screws, is tight it with detector's fixed flange, to prevent the air leakage, between two flanges may the filled rubber cardboard seal packing collar.

(3) Probe head installment:

Probe head's reference gas is provides depending on the air natural convection, the probe head needs the level installment, the reference was mad that with the standard was mad under the connection corresponding dynasty, the probe head installs between the flange and a transition flange must fill in the rubber cardboard, in order to avoid the spatial gas leakage enters the flue, affects the survey accuracy.

Pokes head in the reason to leave above boiler endophragm 150mm, causes filter's porous ceramic exposition part back to flow to (filter direction to the haze to be possible rotation to avoid the ceramic body alone) the gas washout, the extension service life.

When the probe head thrusts the flue, is prevents the zirconium pipe explosion, the suitable partition thrusts gradually, generally take 10~20cm/min as good. (See FIG 7)

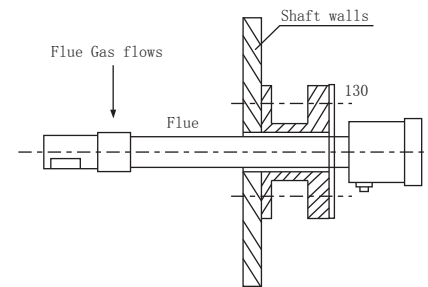

FIG 6 Probe Installation

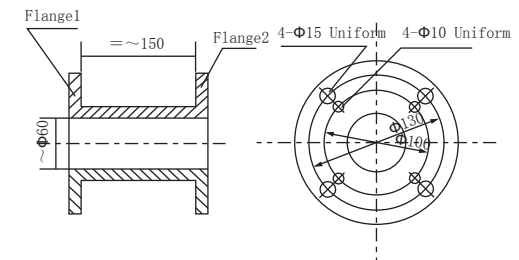

FIG 7 Transition Flange

Background electric potential adjustment

(1) Probe head in air: After measuring appliance wiring correct unmistakable electrifies, the measuring appliance starts to the zirconium oxide electrode to carry on the heating, and so on electrodes heat up after the normal work temperature, the stable 30 minutes, this time examine the oxygen electrode potential, namely for this reason electrode's background electric potential. Generally in $\pm 3\text{mV}$ within, revised the E0 value by now then.

(2) Probe head in flue: In the standard was mad that the connection input standard was mad, the current capacity is 30~50ml/min. Stable one minute later looks at measuring appliance's oxygen content, if the deviation standard were mad, revises the E0 value, causes it demonstration and the standard is mad equally.

For example: When 650°C , 10% standard gas, the table look-up this time the theory output should be 14.36mV, but electrode actual output 14.03mV. By now E0 should be $14.03\text{mV} - 14.36\text{mV} = -0.33\text{mV}$.

(3) After the background electric potential hypothesis completes, may the oxygen quantity respectively be 1%, 5%, 9% about standard was mad the input zirconium oxide probe head, after treating the reading stably, the error should in 0.4% range.

Secondary instrument appliance's examination

(1) Temperature examination: Turns on 27.022mV in the couple input end, the cold end compensation meets the cu50 copper resistance, the measuring appliance demonstration $650^{\circ}\text{C} + \text{room temperature}$, the allowance error $\pm 3^{\circ}\text{C}$.

(2) Oxygen quantity examination: Supposes background electric potential E0 is 0, the adjustment thermo-element input signal, causes the temperature for 650°C , respectively inputs 73.96mV, 28.15mV, 14.36mV, 6.3mV and 0.58mV in a zirconium input end, the corresponding oxygen quantity respectively is 0.5%, 5.0%, 10.0%, 15.0% and 20.0%, allowance error $\pm 0.1\%$.

五 Zirconium Probe Installment

Zirconium Probe Installment

(1) Pick-up point choice:

Pokes head in the pick-up point flue gas temperature should tally is smaller than 600°C request, generally speaking, the flue gas temperature is low, the probe head service life is long, the flue gas temperature is high, the service life is short. The probe head cannot install in the flue gas not mobile dead angle, also cannot install in the flue gas flowing very quick place (for example in some bypass gas channel dilatancy cavity).

Moreover the request flue leaks air is small, the probe head installment service is convenient, regarding medium, small boiler, suggested installs after the economizer the superheater, because the boiler system flue gas flows from the chamber to the steam drum, passes through the superheater, the economizer, the air pre-heater, by drawing fan after recovery processing from chimney emissions. If the measuring point too approaches the flue gas chamber export, as a result of the

四 Measuring Appliance Operation, Front Panel

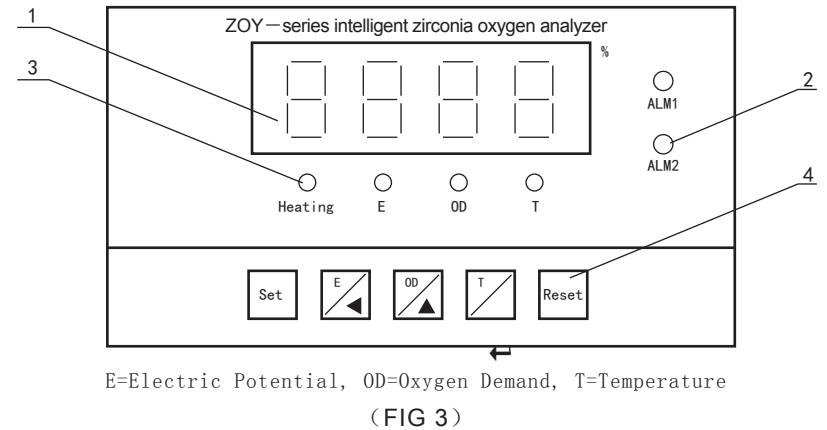

1. Demonstration 4 LED Digit Demonstration

When normal work, may demonstrate the oxygen content, the electrode potential, the electrode temperature.

When setting, demonstrates the multi-purpose parameter values.

2. Alarm Indicator Lamp

ALM1: When the oxygen size surpasses the upper limit warning setting value instruction.

ALM2: When the oxygen size is lower than the lower limit warning setting value instruction.

3. Condition Indicating Lamp

Heating: Electric stove heating status indicator.

Electric Heating: Oxygen electrode potential value instruction. (mV)

Oxygen Quantity: Oxygen content value instruction. (%)

Temperature: Oxygen electrode temperature instruction. ($^{\circ}\text{C}$)

4. Functional Key

Set: Presses this key in the active status to enter the establishment parameter condition.

E / ◀ Key: Presses this in the working state, the demonstration oxygen electrode's electric potential value. Corresponds the indicating lamp to be bright, presses this key in the establishment condition for the left shift function.

OD / ▲ Key: Presses this in the working state, the demonstration oxygen content value. Corresponds the indicating lamp to be bright, in the establishment condition, presses this key for the rise function.

T / ↵ Key: Presses this in the working state, demonstrates the oxygen electrode's temperature value. Corresponds the indicator light to be bright, in the setting condition, presses this key for the confirmation function.

Reset: In the setting state, after setted all parameters, presses this key enter working state.

5. Rear panel

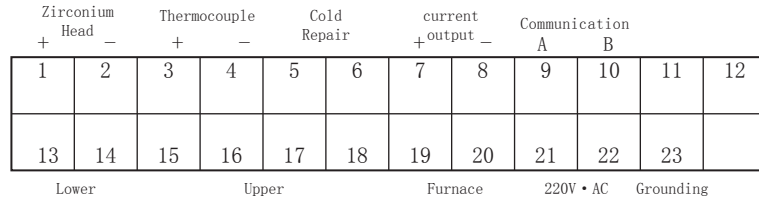

(FIG 4)

- 1#, 2# by Zirconium Head, 1 foot by positive.
 3#, 4# by Thermocouple, 3 foot by positive.
 5#, 6# by Cold End Compensating Resistance: cu50.
 7#, 8# is Current Output, 7 foot by positive.
 9#, 10# is RS-485 Communication Output, 9 foot by positive.
 13#, 14# is Low Limit Alarm Out-port, 16#, 17# for Upper Limit Alarm Out-port.
 19#, 20# is Furnace Heating Output.
 21#, 22# is Power: 220V • AC.
 23# is Grounding.

Wall Suspension Type Oxygen Analyzer Binding Clamp Schematic Drawing

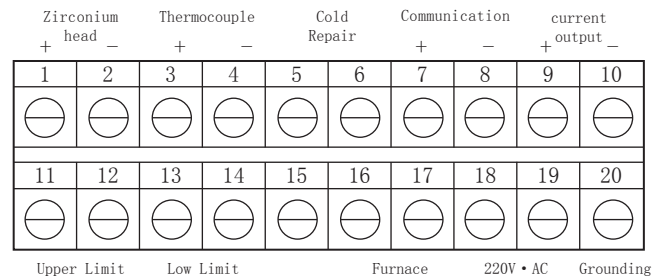

(FIG 5)

- 1#, 2# is Zirconium Input End, 1 by positive, 2 by negative.
 3#, 4# is Thermocouple Input End, 3 by positive, 4 by negative.
 5#, 6# is Compensating Resistance Input End.
 7#, 8# is RS-485 Communication Input End, 7 by positive, 8 by negative.
 9#, 10# is Current Output-port, 9 by positive, 10 by negative.
 11#, 12# is Upper Limit Alarm Out-port, 13#, 14# is Low Limit Alarm Out-port.
 16#, 17# is Furnace Heating Voltage Out-port.
 18#, 19# is AC • 220V Input End
 20# is Grounding.

6. Measuring Appliance Operation

After measuring appliance circular telegram, presses set key, enter the setting password condition. Input password [0][0][1][5]. Presses “←” key, enter the Parameter set condition. In the setting condition, presses “Reset” key, Returns to the work measuring condition. If 10 seconds do not press any, also returns to work automatically the measuring condition.

In the setting condition, presses “▲” key, distinction demonstration:

- E0: Background Electric Potential (mV)
- OL: Electric Current Output Zero Oxygen Quantity (%)
- OH: Electric Current Output Fullness Oxygen Quantity (%)
- LL: Low Limit Alarm Value (%)
- HH: Upper Limit Alarm Value (%)
- T: Electrode Working Temperature (°C)
- H0: Electric Current Output Fullness Datum Value (994)
- H1: Electric Current Output Zero Position Datum Value (205)
- OF: Electric Current Output Mode
- AF: Mailing Address

- (1) E0: Background Electric Potential Revision. When the measuring appliance demonstrates E0, presses “←” key, the measuring appliance demonstrates beforehand background electric potential value. Presses “▲” “←” key Revision, After improving, presses “◀” key again, returns to the E0 condition, by now pressed “▲” key again.
- (2) OL, OH: Electric current output zero and fullness hypothesis. Electric current outputs 0mA or 4mA corresponds the OL value, 10mA or 20mA corresponds the OH value, in 0~20.6 range.
- (3) LL, HH: Lower limit and upper limit alarm value hypothesis.
- (4) T: Oxygen electrode working temperature hypothesis. This parameter establishment zirconium oxide electrode normal work's temperature, establishes generally in 550°C ~750°C range.
- (5) H0, H1: Output current adjustment. H0 is PP output regulation, datum is (994). H1 is zero output regulation, datum is (205), generally does not use the revision.
- (6) OF: Electric current output mode choice. When e Supposes is 0, the measuring appliance outputs is 0~10mA; When e Supposes is 1, the measuring appliance outputs is 4~20mA.
- (7) AF: RS-485 Mailing Address Setting.

Note: After each time revision parameter, must according to “←” key, otherwise revises the parameter is unable to preserve.